

Residential Grade Silencers

Disc Shape with 2" Insulation (24-29 dBA). Model NTRS2-D

Nett Technologies' Residential Grade Silencers are designed to achieve maximum performance with the least amount of backpressure. These reactive/absorptive silencers are typically used for reciprocating or positive displacement engines where noise level regulations are medium-low.

FEATURES & BENEFITS

- Over 25 years of excellence in manufacturing noise and emission control solutions
- Compact modular designs providing ease of installations, less weight and less foot-print
- Responsive lead time for both standard and custom designs to meet your needs
- Customized engineered system solutions to meet challenging integration and engine requirements

OPTIONS

- Versatile connections including ANSI pattern flanges, NPT, slip-on, engine flange, schedule 40 and others
- Aluminized Steel, Stainless Steel 304 or 316 construction
- Two inlet configuration is available upon request

ACCESSORIES

- Hardware Kits
- Flexible connectors and expansion joints
- Elbows
- Thimbles
- Raincaps
- Thermal insulation: integrated or with thermal insulation blankets

TYPICAL ATTENUATION CURVE

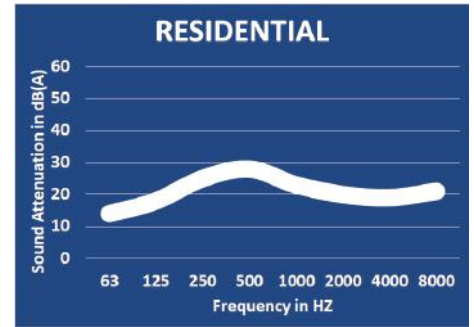

Please see our accessories catalog for a complete listing.

Contact Nett Technologies with your projects design requirements and specifications for optimized noise control solutions.

TYPICAL CONFIGURATIONS

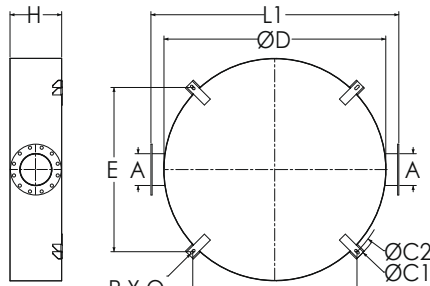

END IN END OUT (EI-EO)

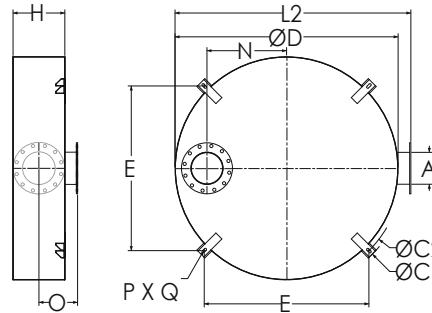

BOTTOM IN END OUT (BI-EO)

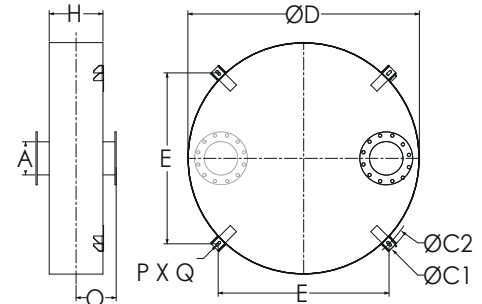

BOTTOM IN TOP OUT (BI-TO)

PRODUCT DIMENSIONS (in)

Model*	A	D	H	L1	L2	O	N	E	C1	C2	P	Q
	Outlet	Dia	Height	EI-EO	BI-EO		Max				Slot Dia	Slot L
NTRS2-D4	4	22	7	30	26	7.5	5.5	17.13	29	24.25	0.625	1.375
NTRS2-D5	5	24	8	32	28	8	6	18.5	31	26.25	0.625	1.375
NTRS2-D6	6	28	9	36	32	8.5	7.5	21.38	35	30.25	0.625	1.375
NTRS2-D8	8	34	13	42	38	10.5	9.25	25.63	41	36.25	0.625	1.375
NTRS2-D10	10	38	14	46	42	11	10	29	46	41	0.75	1.75
NTRS2-D12	12	40	17	48	44	12.5	9.5	30.38	48	43	0.75	1.75
NTRS2-D14	14	44	18	52	48	13	10.5	33.25	52	47	0.75	1.75
NTRS2-D16	16	46	21	54	50	14.5	10.25	34.63	54	49	0.75	1.75
NTRS2-D18	18	60	25	68	64	16.5	16.5	45.25	69	64	1	2
NTRS2-D20	20	66	30	74	70	19	18.25	49.5	75	70	1	2

* This 2" internally insulated model provides a great reduction in the outer surface temperature. Other models and custom designs are available upon request. Dimensions subject to change without notice. All silencers are equipped with drain ports on inlet side. The silencer is all welded construction and coated with high heat black paint for maximum durability.